

Mighty in Miniature
Space-Pack & Space-Fill

www.eighteeth.com

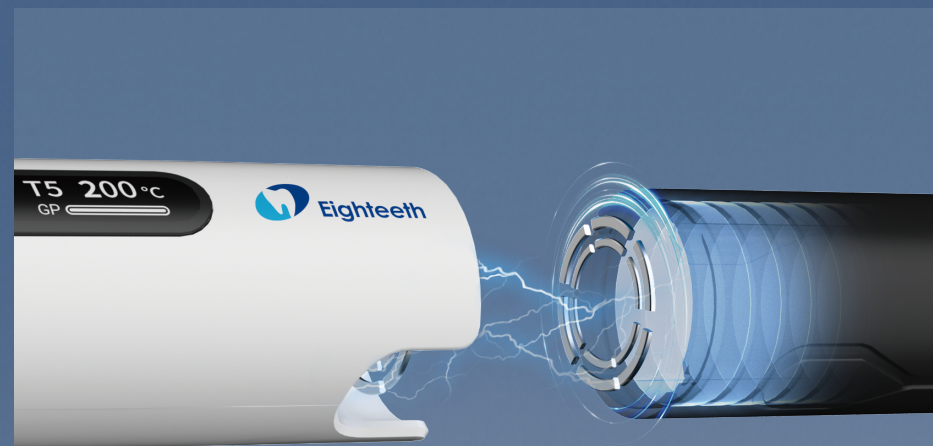



Magnetic Fluency Consistent Power

Milliohm-level, low resistance for rapid heating and sustained power
Magnetic design enables swift, hassle-free exchange



Dual Battery Configuration for All-Day Productivity

Space-Pack: Powers 800 root canal treatments per battery
Space-Fill: Powers 70 root canal treatments per battery

Lightweight Pen-Style Design

- Slim, ergonomic body for comfortable, effortless grip
- Facilitates easy, precise handling during clinical procedures

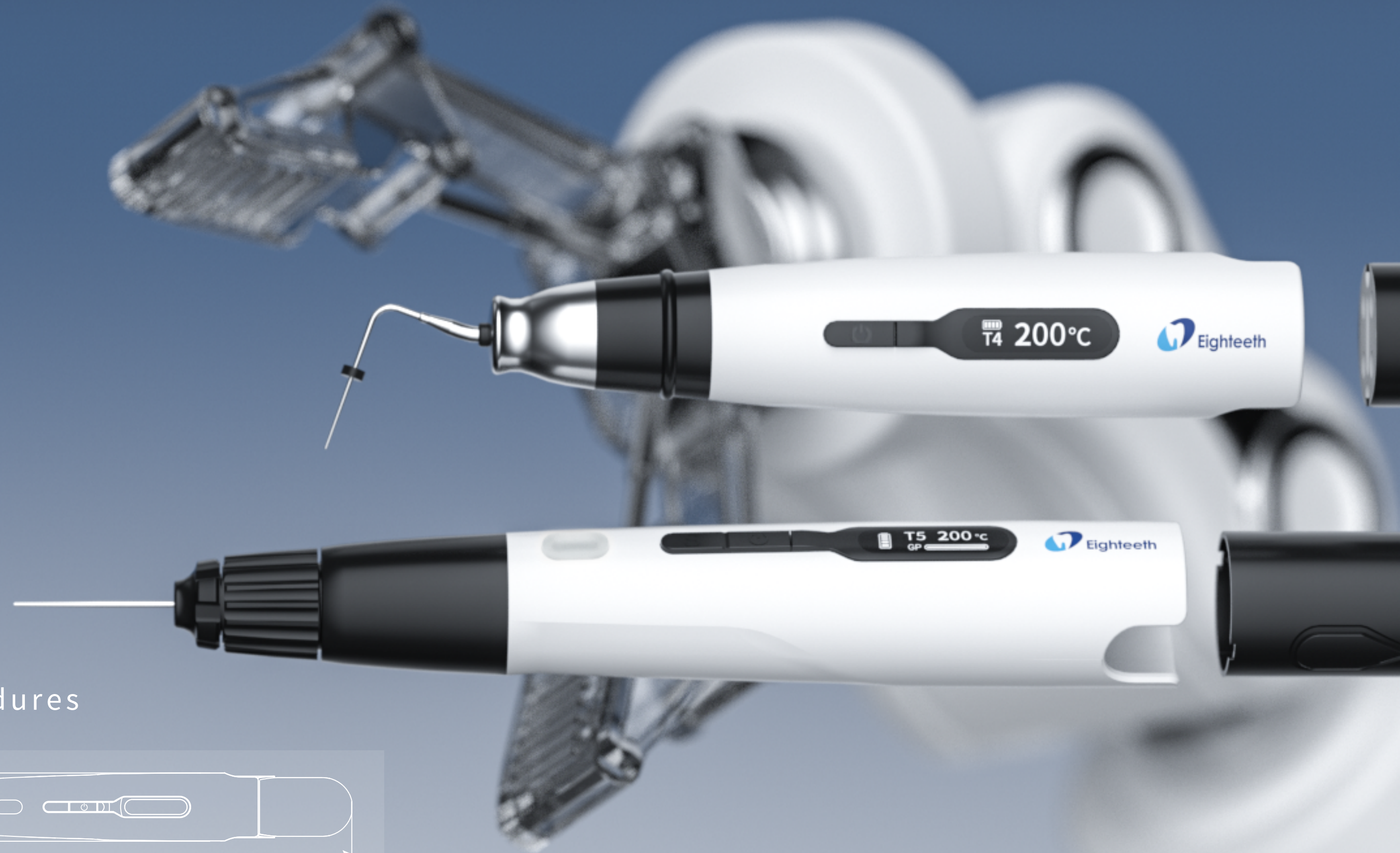
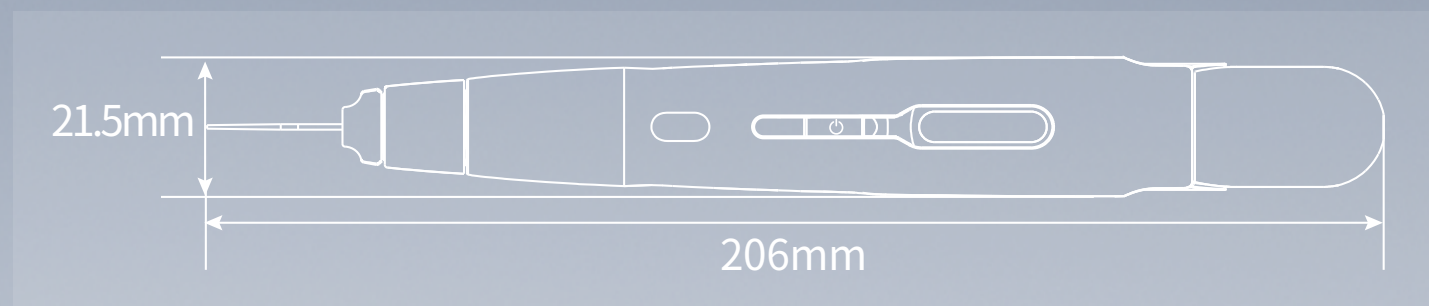
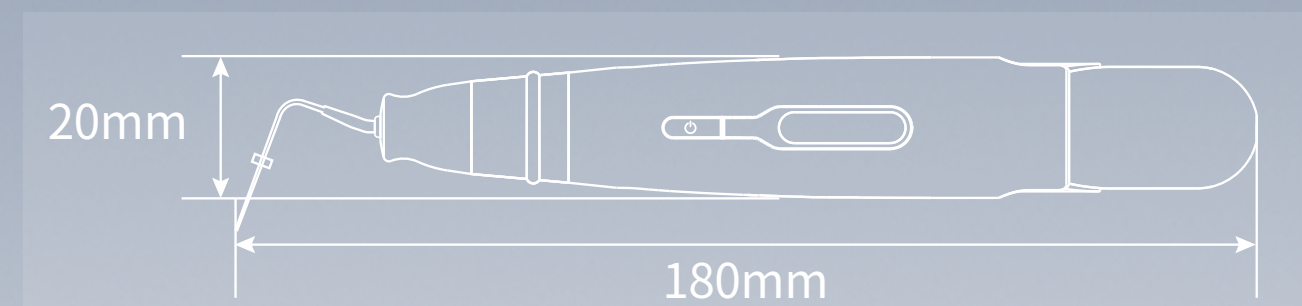

Space-Fill



360° Rotatable Autoclavable Silver Needle

- Innovative coupling technology prevents leakage and overflow
- 999 pure silver maintain thermoplasticity for smooth flow
- Pre-Bent, extra-long design for convenience and visibility



Electric Motorized GP Flow

- Instant start/stop, retraction prevents leakage
- Smooth, bubble-free extrusion for dense & precise filling



Five Memory Settings (T1-T5)

- Quick access to personalized configurations



Precision Temperature Control

- 3 adjustable filling speeds: low, medium, high
- Temperature range: 100°C - 200°C



LED Display Screen

- Real-Time monitoring of gutta-percha remaining





Instantaneous Heating

Heating to 180°C takes only 10 seconds

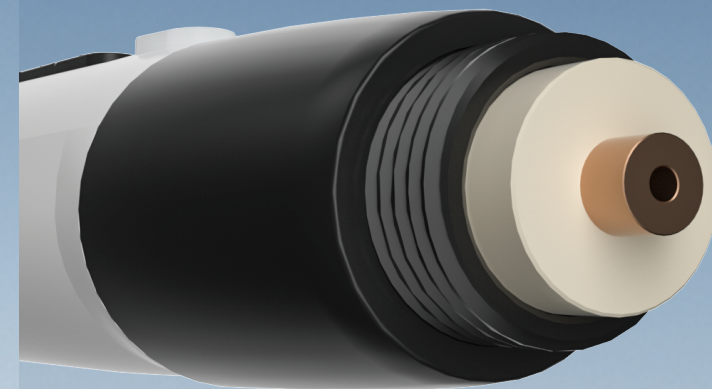

Leakage-Proof Outlet Design

Innovative extrusion outlet structure effectively prevents leakage and simplifies the cleaning process

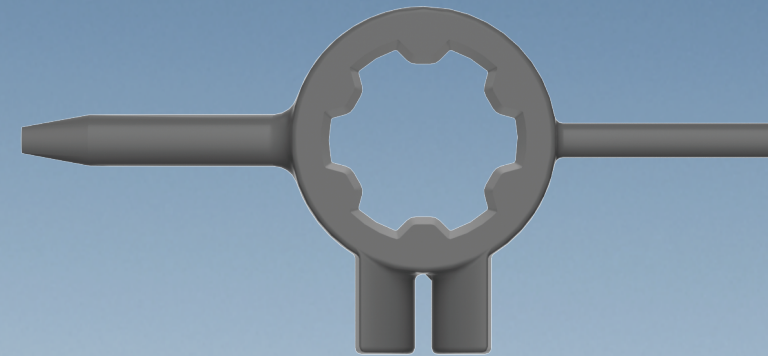

Standard Multi-Function Wrench

-Outlet Residue Removal & Inner Tip Cleaning
-Needle Angle Rotation
-Bending adjustments without breakage

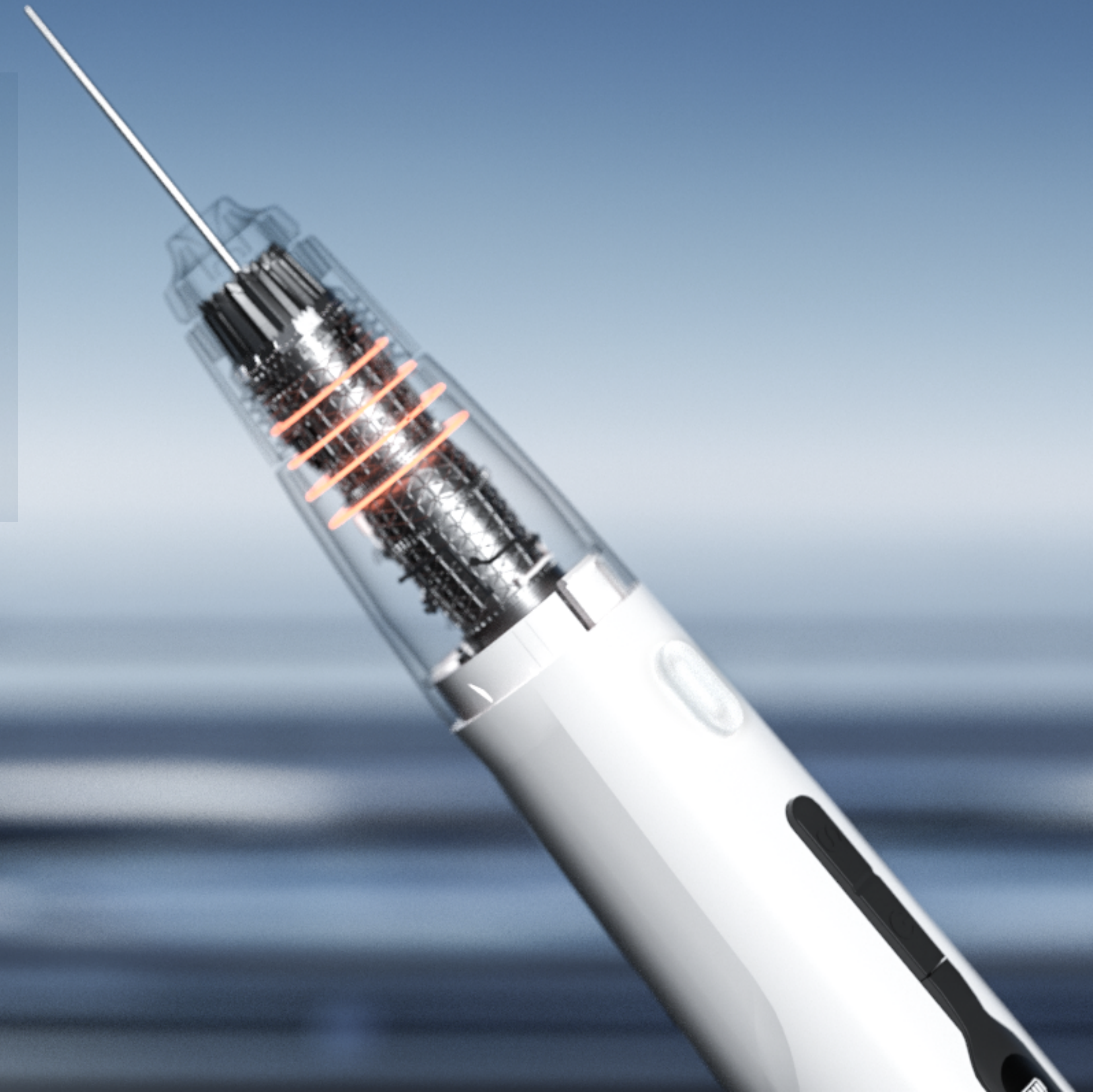

Innovative Two Filling Modes for Diverse Clinical Needs

- Standard Filling Mode
- Inject Control Mode with five selectable settings

Standard Insulating Sleeve for Enhanced Safety

Comprehensive Fill Tip Selection

Space-Pack



Upgraded Heating Tip

- Targeted 4-5mm tip end heating for precision cutting
- High toughness guarantees enduring reliability



360° Ring Button

- Sensitive control, precise left-right handed operation
- Complete with audible feedback for each press



Five Memory Settings (T1-T5) for Customized Operation



Real-time Temperature Display



Automatic Power-Off Protection

- Adjustable heating time: 3-10 seconds
- Customizable power-off delay for specific procedures

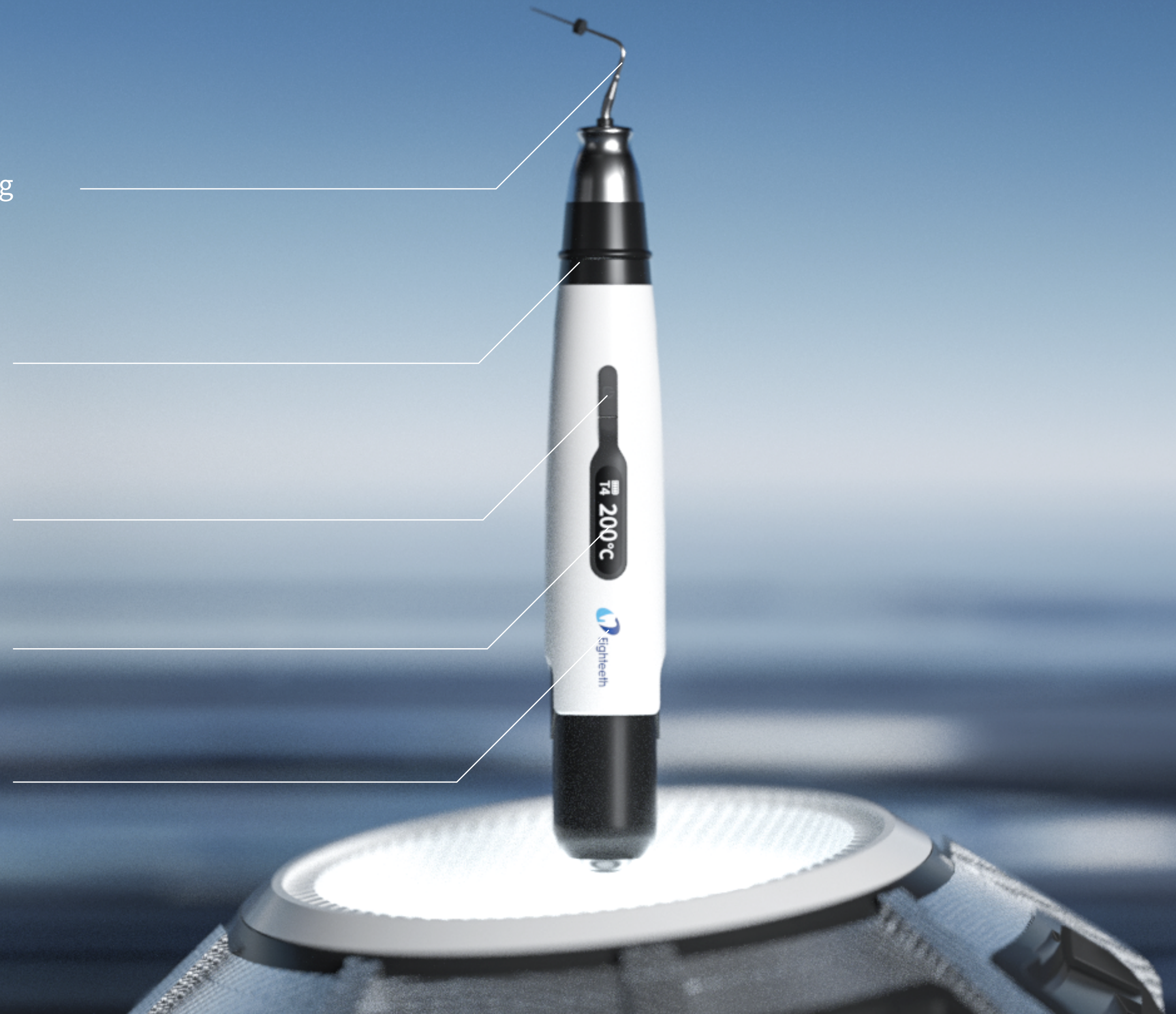

Smart Temperature Control System

- Adaptive compensation algorithm ensures consistent & stable temperatures, and enhances cutting efficiency in challenging conditions including moist environments and complex loads
- Wide adjustable temperature range: 90°C to 250°C for diverse filling materials

Heating Faster, Waiting Less

- Heats up to 200°C in just 0.07 seconds

Diverse Heat Tip Options

- Specialized tips cater to versatile clinical needs
- Tailored heating profiles optimize performance for each application

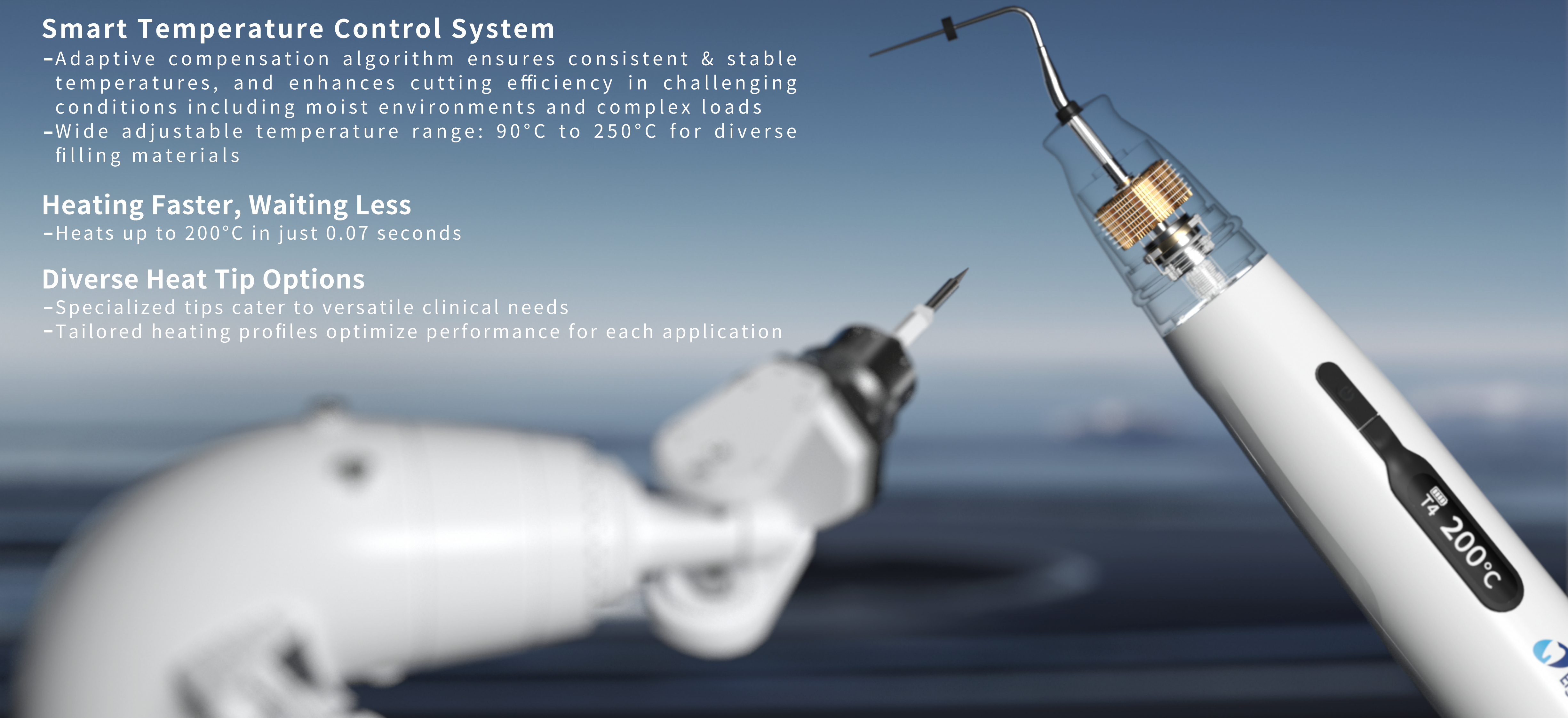

Comprehensive Working Tips for Precision Dentistry

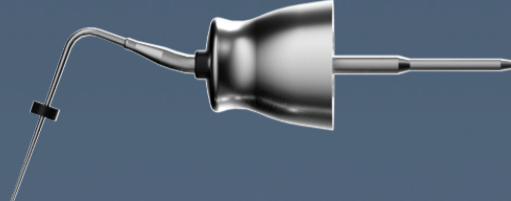
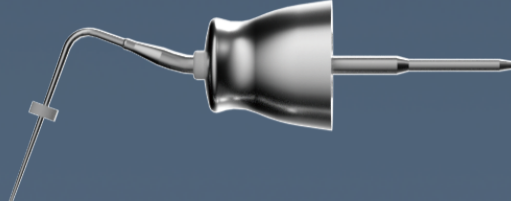
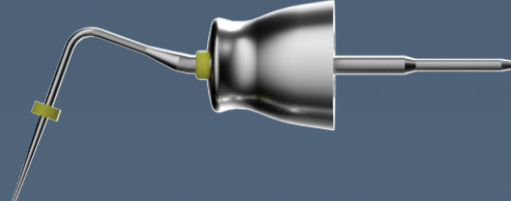
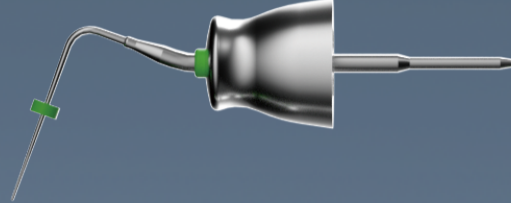
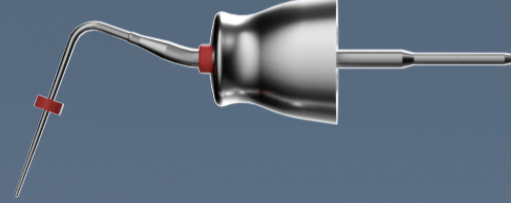
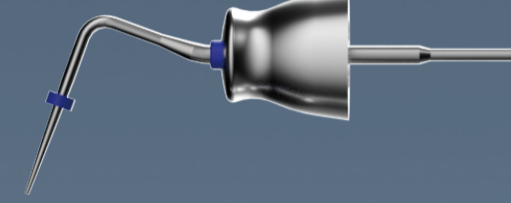
Heat Tip			
Standard <small>*(one for each)</small>	Tip 40φ0.4mm	Tip 45φ0.45mm	Tip 50φ0.5mm
			
Optional	Tip 35φ0.35mm	Tip 55φ0.55mm	Tip 60φ0.6mm
			

Fill Tip			
Standard <small>*(one for each)</small>	23Ga	25Ga	
			

Specification

Space-Pack	
Heating Time	0.07 seconds for 200 °C (By Tip 35φ0.35mm)
Charging Time	1 hour to complete charge
Operating Time	Up to 800 treatments per full charge
Weight (Include Tip)	84g
Length (Include Tip)	180mm

Space-Fill	
Heating Time	10 seconds for 180°C
Charging Time	1 hour to complete charge
Operating Time	Up to 70 treatments per full charge
Weight (Include Tip)	129g
Length (Include Tip)	206mm

